



TIP SHEET

TECHNICAL SUPPORT / INFORMATION

Neither the manufacturer or distributor of this module is responsible for damages of any kind either indirectly or directly caused by this module, except for the replacement of this module in case of manufacturing defects. This guide is subject to change without notice

RFK-441 REMOTE TRANSMITTER KIT

PARTS INCLUDED

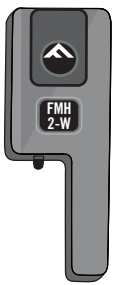

ANT-FMH-2W
ANTENNA

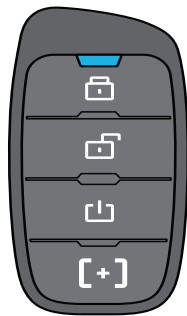

2x RM441
REMOTES



ANTENNA
CABLE

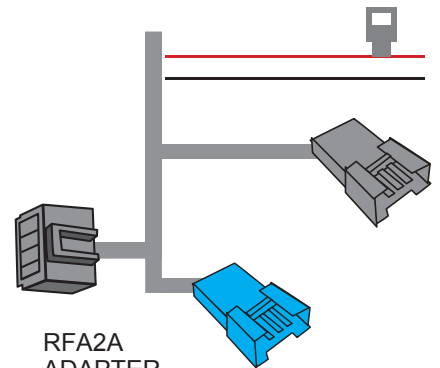

RFA2A
ADAPTER

Overview

There are 5 basic steps to this remote start installation:

1. Preparation
2. Wiring
3. Programming
4. Test the system
5. Button it up!

STEP 2: Wiring

How to make the connections:

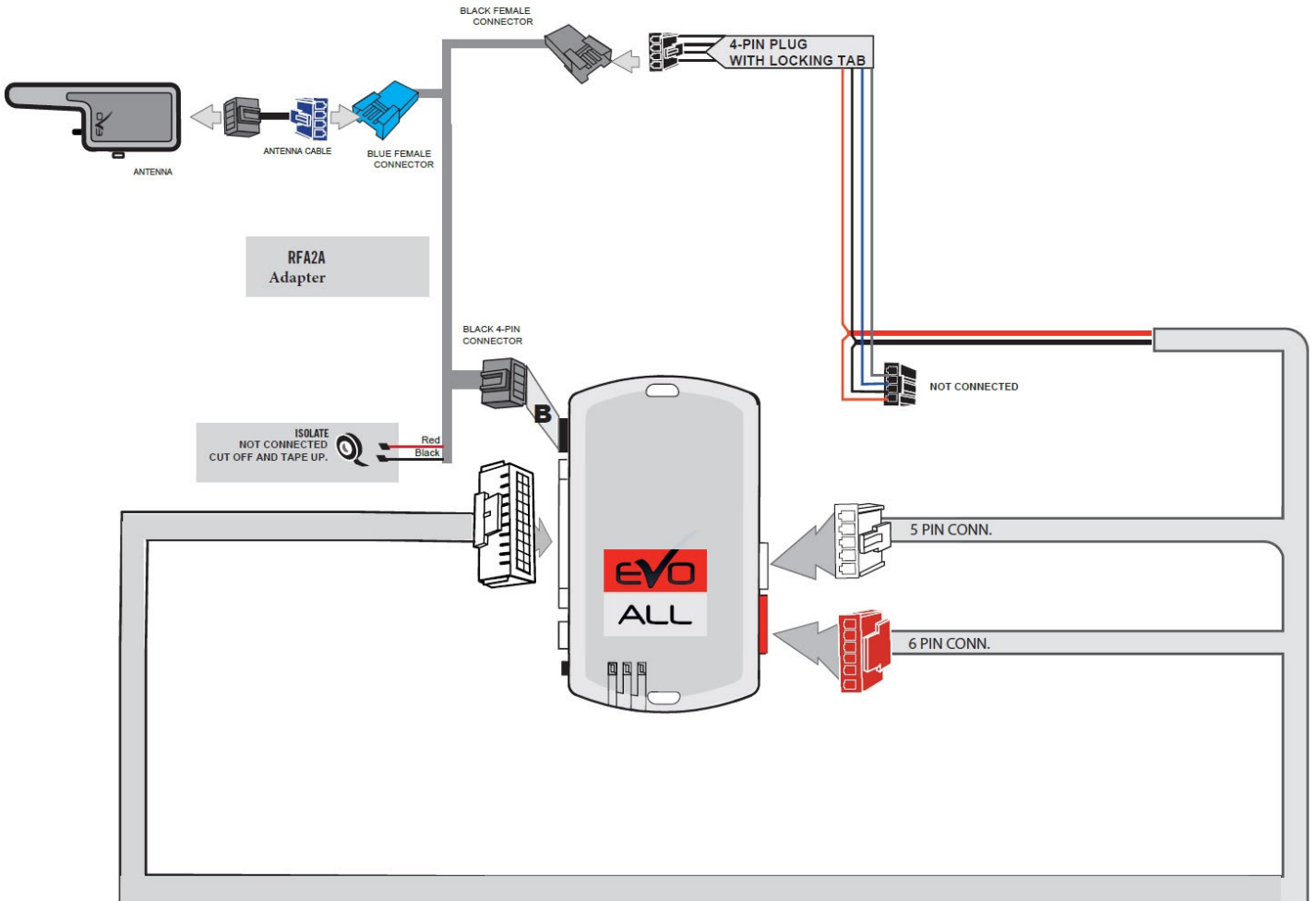

Antenna should be located at top of widow at least one inch away from metal surface.

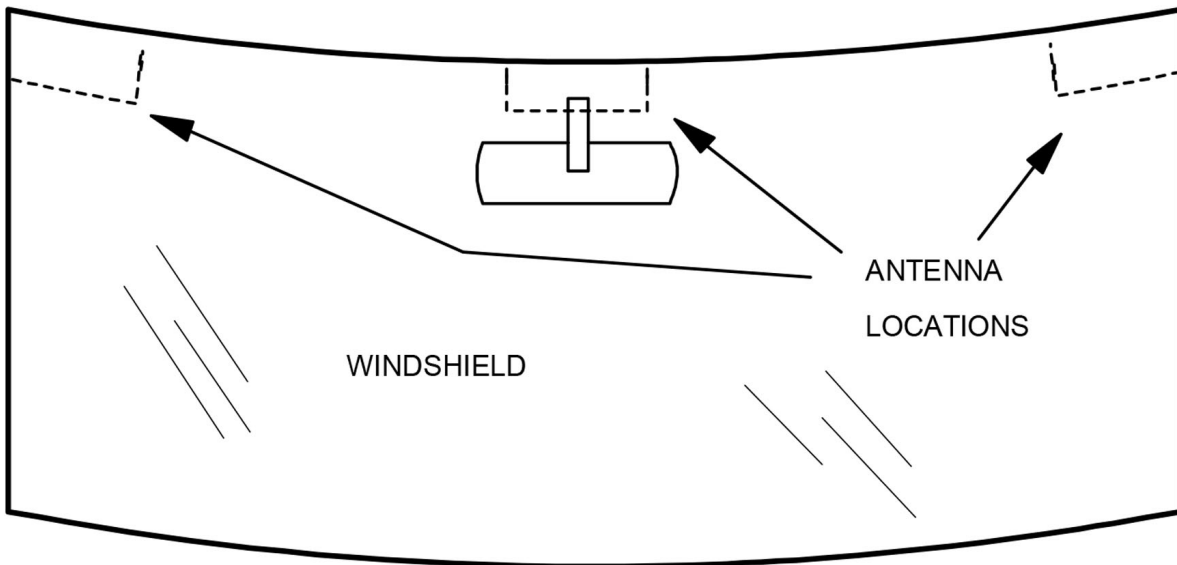

CONNECTION GUIDE WITH T-HARNESS

The 4-pin connector without a locking tab on the T-Harness will not be used.

Use the adapter from the RF kit to plug in-line to the EVO ALL.

Use the (A) 4-pin with locking tab from the T-Harness and plug it into the adapter. Then plug the (B) antenna wire into the blue female plug of the adapter. Mount the antenna and plug it into the other end of the antenna wire. The loose red and black wires are not used. Cut off and tape up.

You are now ready to program the new remotes.

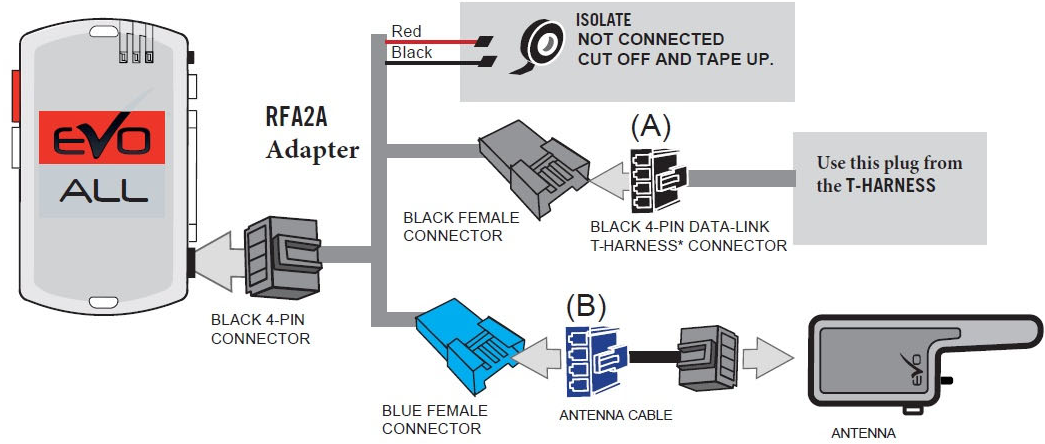

Before plugging in this adapter make sure you cut off and tape up the red and black wires.

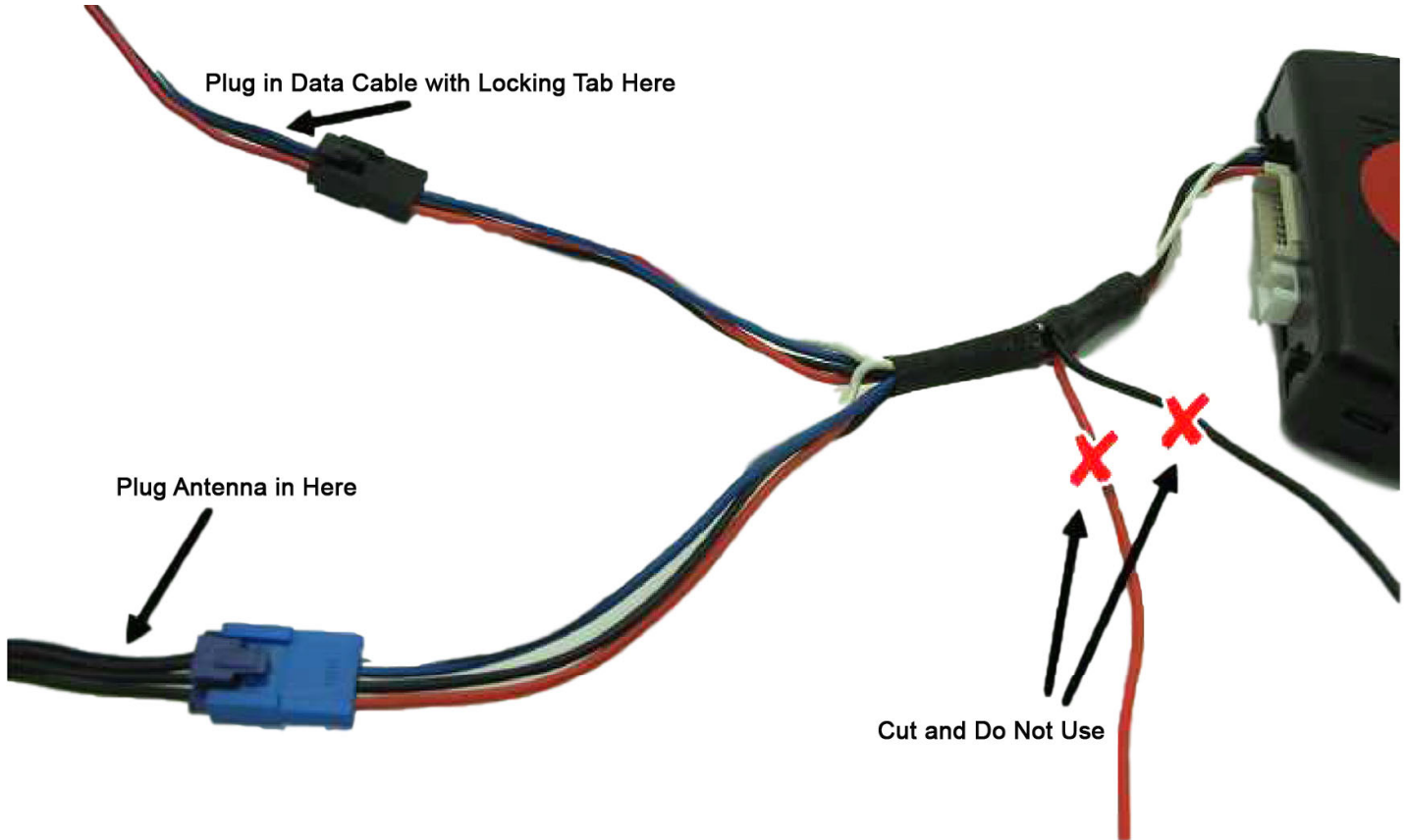

PROGRAMMING REMOTE TRANSMITTER (S)

- 1** 

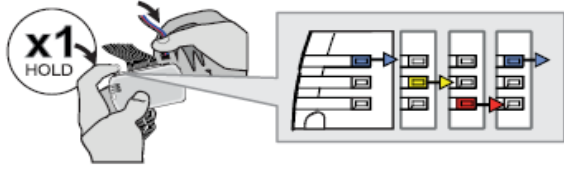

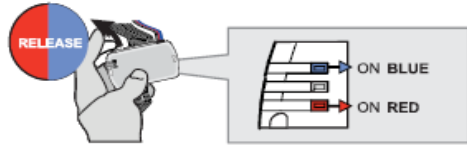

Begin with the 4 Pin (Data-Link) connector unplugged from the EVO-ALL module.
- 2** 

Press and hold the programming button as you insert the black male 4-Pin plug (without locking tab) from the RFA2A adapter.

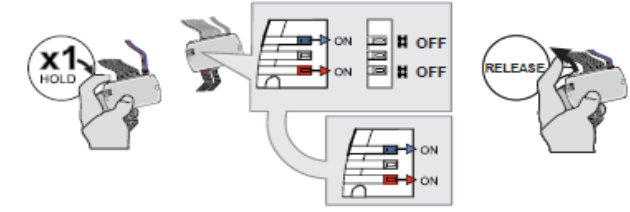
The LEDs will begin to cycle between the colors
- 3** 

Release the programming button at the moment when the LEDs are BLUE & RED.

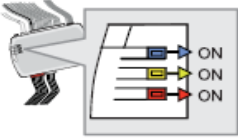

If the LED are not solid BLUE and RED disconnect the 4-Pin connector (Data-Link) and go back to step 1.
- 4** 

Press and hold the programming button. The BLUE and RED LEDs will turn Off. **Wait** until the BLUE and RED LEDs turn back ON, **then release** the button
- | | | | |
|---|--------------------------------------|---|---|
| 5 | OR | | |
| REGULAR KEY VEHICLE | | PUSH-TO-START VEHICLE | |
|  | Turn the key to the ON/RUN position. |  | Press and release the Push-to-Start button to turn ON the ignition.
This can be 1X or 2X depending on the vehicle. |
|  | |  | |

Turn ignition on.



The YELLOW LED will turn on along with the BLUE and RED.

The antenna will flash rapidly.
- 6** 

 **Press**  **Then**  **Press**

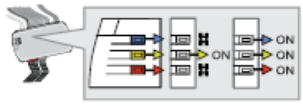
On each Transmitter
Press and release the AUX button (+)
THEN
Press and release the LOCK button



The BLUE and RED LEDs will flash once each time to confirm.
- | | | | |
|---|--|---|---|
| 7 | OR | | |
| REGULAR KEY VEHICLE | | PUSH-TO-START VEHICLE | |
|  | Turn the Ignition to the OFF position to exit programming. |  | Press and release the Push-to-Start button once to turn off the ignition to exit programming. |

Turn Ignition OFF.

The EVO-ALL LEDs will turn Off.









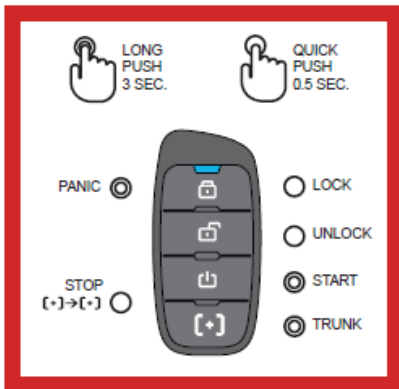





The remotes are now programmed.

STEP 4: Test the system

Remote starter functionality

Once all wiring and programming are done, you should test the system to make sure everything is working properly before you close up the installation.



BUTTON	COMMAND	TIME PRESSED	DESCRIPTION
 PRESS	LOCK	1 SECOND	Locks all doors, arms the anti-theft system and activates the Alarm (if available).
 PRESS	PANIC	3 SECONDS	Press LOCK for 3 seconds to activate the Panic.
 PRESS	UNLOCK	1 SECOND	Unlocks all doors, disarms the anti-theft system and deactivates the Alarm (if available).
 PRESS	START	3 SECONDS	Remote start the vehicle. Press START again to reset the runtime.
 PRESS	TRUNK	3 SECONDS	Opens the trunk, and deactivates the Alarm (if available). The Alarm ignores the trunk zone until it is closed.
 PRESS RELEASE PRESS	STOP	1 SECOND	Cancel the remote start sequence.
 PRESS RELEASE PRESS	AUXILIARY1	1 SECOND	Activates the auxiliary1 (if available).
 PRESS RELEASE PRESS	AUXILIARY2	1 SECOND	Activates the auxiliary2 (if available).
 PRESS RELEASE	 + 	UNTIL THE RED LED TURN ON	Disable all the remote's buttons for safety. ! The RED LED will come on whenever a button is pressed when the remote is DISABLED.
DISABLE THE REMOTE BUTTONS			
 PRESS RELEASE	 + 	UNTIL THE GREEN LED TURN ON	Enables the buttons on the remote.
ENABLE THE REMOTE BUTTONS			

1. With the key removed from the ignition, press the included remote for 3 seconds and release to activate the remote start.

If everything has been installed and programmed correctly, a few seconds later the gauges will power up and the parking lights (if connected) will flash, and a few more seconds later the vehicle will start.

2. Make sure the vehicle stays running, and that the climate controls are working.

The engine will remain running for the programmed run time or until the brake pedal is pressed. The engine can be turned off by pressing the button again for 3 seconds.

3. If your test was unsuccessful, go back and re-check your wiring and programming. If you used T- Taps, make sure they are all attached correctly. Poorly made T-Tap connections are the #1 cause for tech support calls. Also, remember that T-Taps should never be used on data connections. Depending on the vehicle, those connections could be labeled Data, Can Hi, Can Low, IMMO, IMI, RX, TX or Passlock.

Once you've completed testing the system, it's time to close it up.

STEP 5: Button it up

Finishing the remote start installation

After confirming that everything works properly, cap off or tape the ends of any wires you're not using to avoid grounding or other contacts.

- Now gather up all the wiring and neatly bundle it together using zip ties or electrical tape to prevent the wires from interfering with any of the moving parts under the dash.
- Test the system often when you are putting your vehicle back together.
- Find a secure place to put the remote start module and use zip ties to secure it. Be careful not to zip tie near your connections as it may create a bad connection.
- Replace any interior vehicle panels that were removed to gain access to the needed wires, in reverse order that they were removed.
- Test the system as you reinstall the panels in your vehicle to make sure you do not pull something loose or pinch a wire. Be careful not to run a screw through a wire or pinch a wire while reinstalling panels.

If you have any installation questions or problems, call for tech support

520.579.1531

Copyright 2020 Kleinn Automotive Accessories